

# FREESTANDING ALUMINUM TOWER MODEL #16-50

TOTAL WEIGHT: 171 LBS.

WIND LOADING:

80 mph	16.5 Sq. Ft.
100 mph	10.5 Sq. Ft.
110 mph	7.0 Sq. Ft.

Contact Universal Towers to confirm geographical location of your tower and all wind load implications

14-TOP

18-TAPR

22-TAPR

26-TAPR

26-STRT

B-26

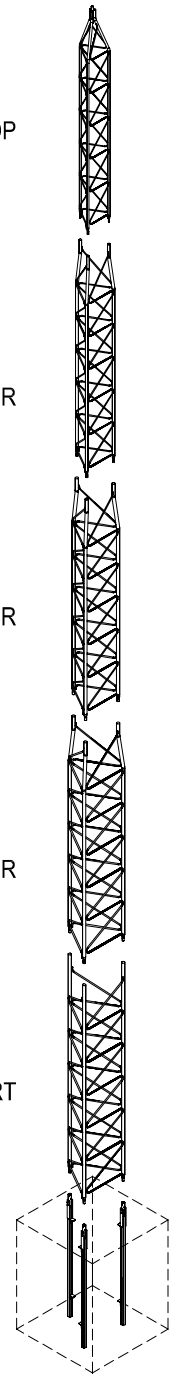
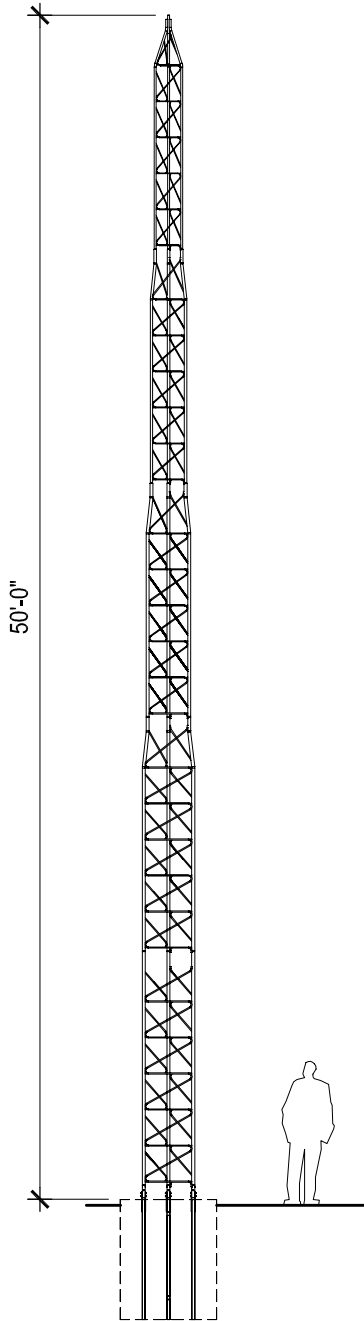

WARRANTY

UNIVERSAL TOWERS ARE WARRANTED AGAINST DEFECTIVE MATERIAL OR WORKMANSHIP AND ARE SUBJECT TO REPAIR OR TO MATERIAL REPLACEMENT ONLY IF FAILURE RESULTS FROM THESE FACTORS WITHIN ONE YEAR FROM PURCHASE BY USER. THIS WARRANTY DOES NOT EXTEND TO ANY OF OUR PRODUCTS WHICH HAVE BEEN SUBJECTED TO MISUSE, NEGLIGENCE, ACCIDENT, IMPROPER INSTALLATION OR APPLICATION, NOR SHALL IT EXTEND TO UNITS WHICH HAVE BEEN REPAIRED OR SUBSTANTIALLY ALTERED OUTSIDE OF OUR FACTORY. THIS WARRANTY IS IN LIEU OF ALL OTHER WARRANTIES EXPRESSED OR IMPLIED.

ELEVATION

2

SCALE: 1/8"=1'=0"

ISOMETRIC

1

SCALE: N.T.S.

ALUMINUM TOWER

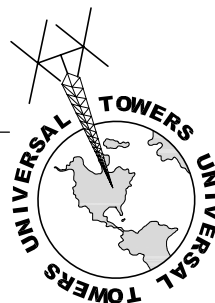

UNIVERSAL TOWERS  
A DIVISION OF  
UNIVERSAL MANUFACTURING CORP.  
43900 GROESBECK HWY.  
CLINTON TOWNSHIP, MI 48036  
PH: (586) 463-2560  
FAX: (586) 463-2964

JOB NO.:

COMPONENT:

16-50

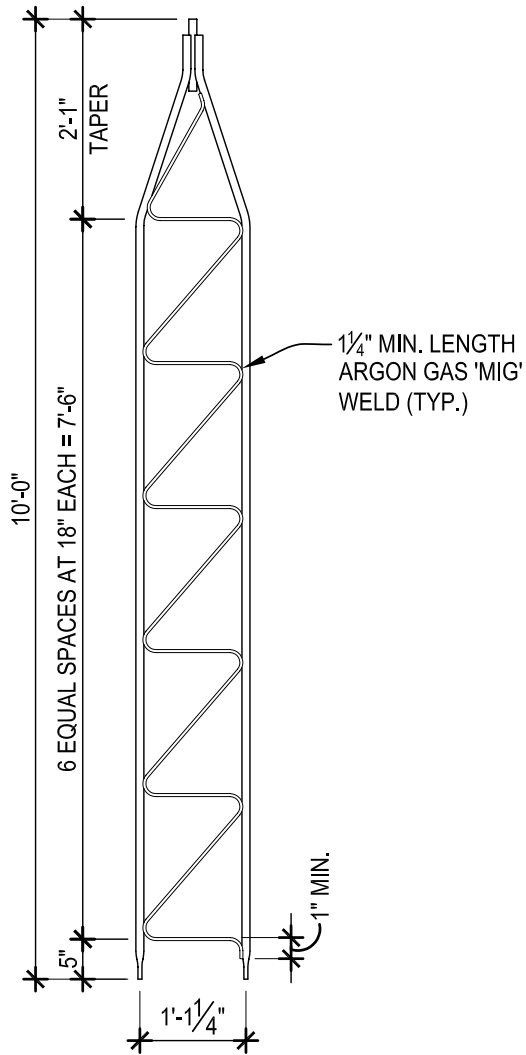

**ELEVATION**

SCALE: 1/2"=1'-0"

**2**

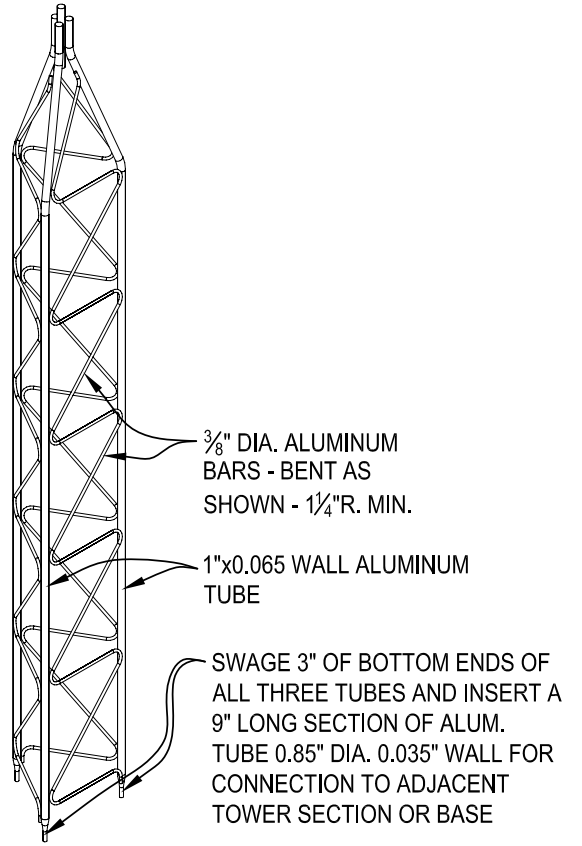

**ISOMETRIC**

SCALE: N.T.S.

**3**

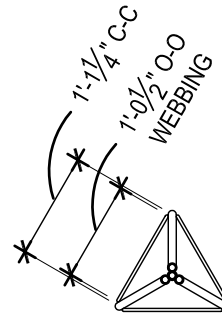

**PLAN VIEW**

SCALE: 1/2"=1'-0"

**1**

**TOP SECTION**



**UNIVERSAL TOWERS**  
 A DIVISION OF  
 UNIVERSAL MANUFACTURING CORP.  
 43900 GROESBECK HWY.  
 CLINTON TOWNSHIP, MI 48036  
 PH: (586) 463-2560  
 FAX: (586) 463-2964

JOB NO.:

COMPONENT:

14-TOP

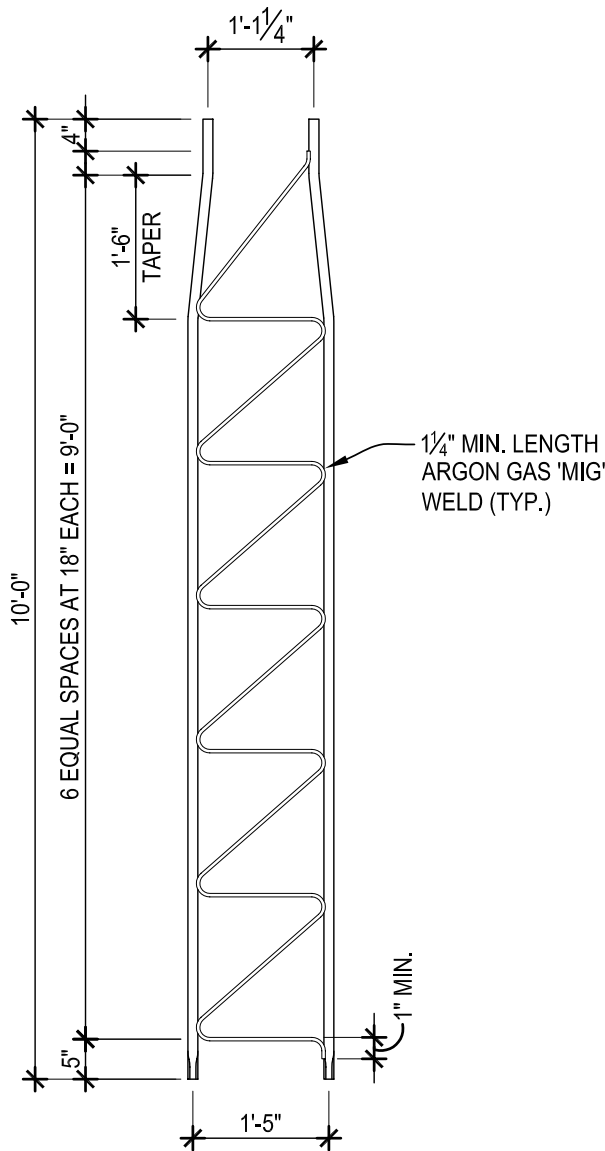

**ELEVATION** 2  
 SCALE: 1/2"=1'-0"

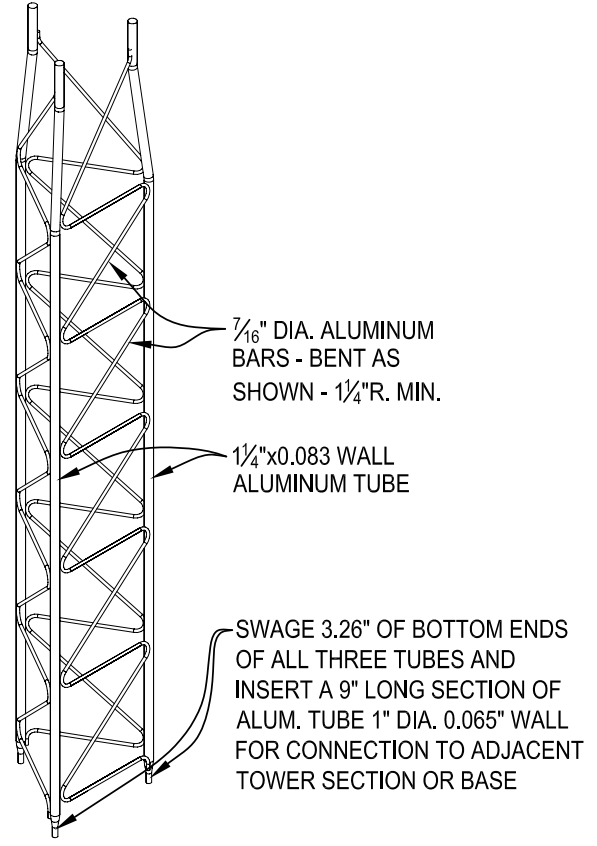

**ISOMETRIC** 3  
 SCALE: N.T.S.

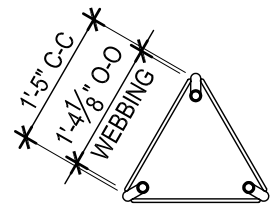

**PLAN VIEW** 1  
 SCALE: 1/2"=1'-0"

# TAPERED SECTION



**UNIVERSAL TOWERS**  
 A DIVISION OF  
 UNIVERSAL MANUFACTURING CORP.  
 43900 GROESBECK HWY.  
 CLINTON TOWNSHIP, MI 48036  
 PH: (586) 463-2560  
 FAX: (586) 463-2964

JOB NO.:

COMPONENT:  
**18-TAPR**

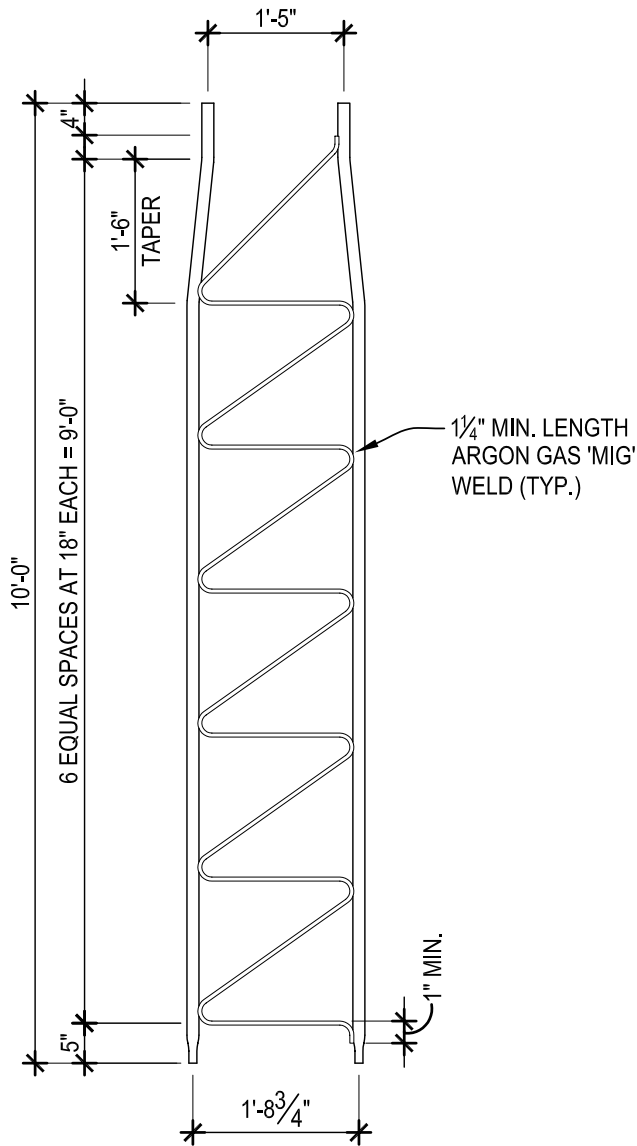

**ELEVATION** 2  
SCALE: 1/2"=1'-0"

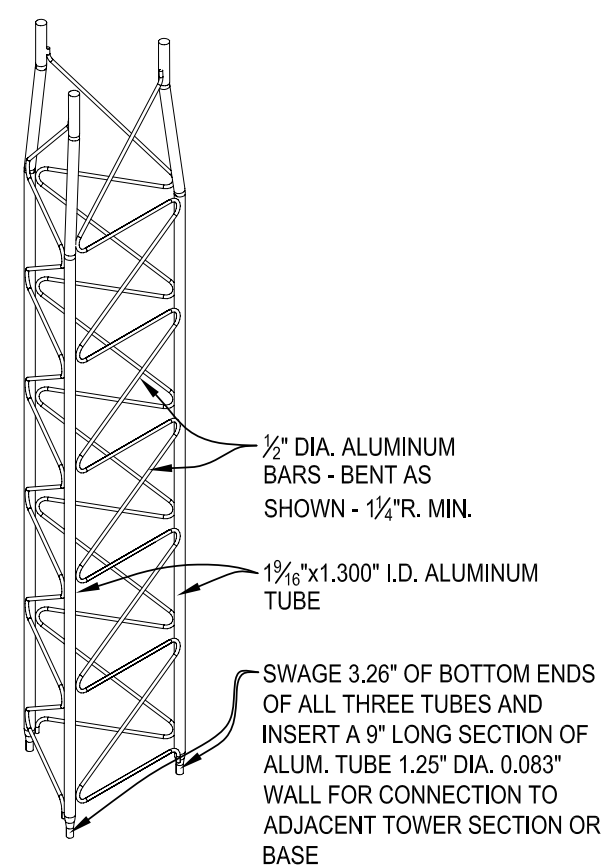

**ISOMETRIC** 3  
SCALE: N.T.S.

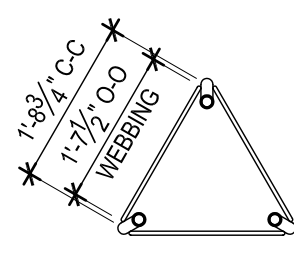

**PLAN VIEW** 1  
SCALE: 1/2"=1'-0"

# TAPERED SECTION



**UNIVERSAL TOWERS**  
A DIVISION OF  
UNIVERSAL MANUFACTURING CORP.  
43900 GROESBECK HWY.  
CLINTON TOWNSHIP, MI 48036  
PH: (586) 463-2560  
FAX: (586) 463-2964

JOB NO.:  
COMPONENT:  
**22-TAPR**

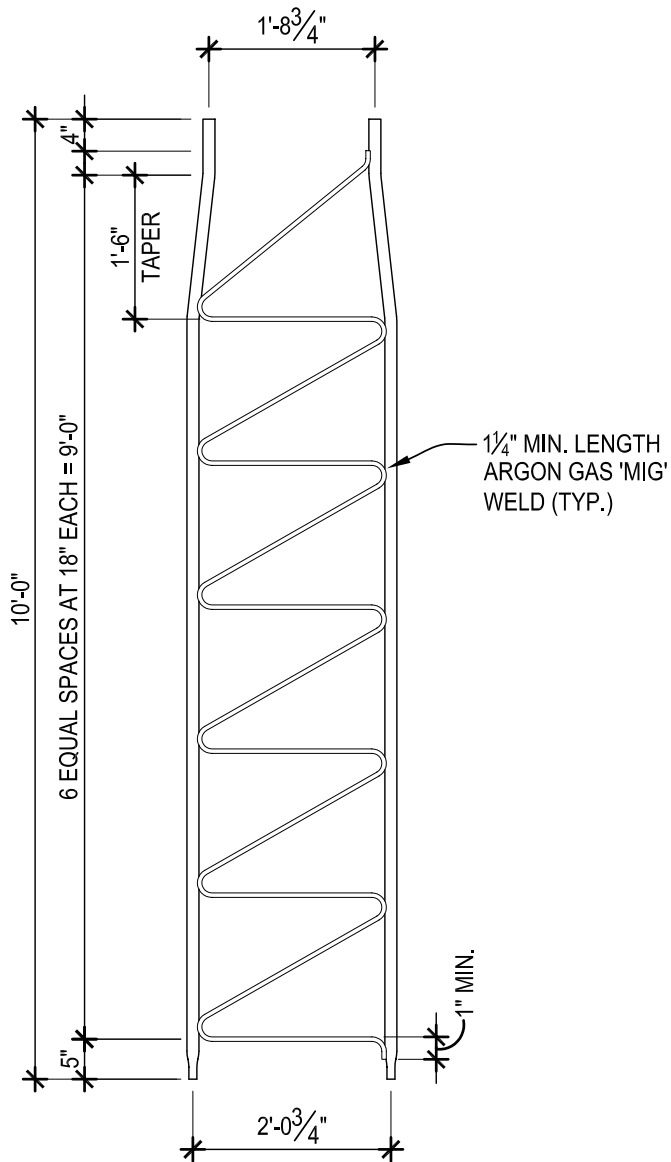

**ELEVATION** 2  
 SCALE: 1/2"=1'-0"

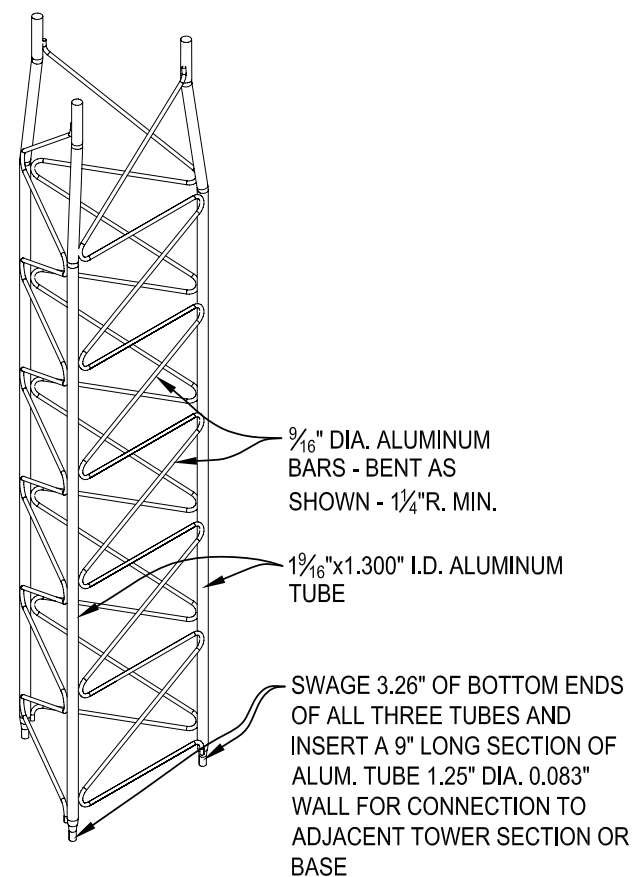

**ISOMETRIC** 3  
 SCALE: N.T.S.

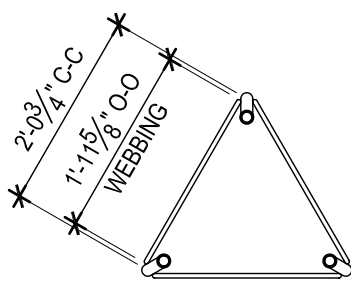

**PLAN VIEW** 1  
 SCALE: 1/2"=1'-0"

# TAPERED SECTION



**UNIVERSAL TOWERS**  
 A DIVISION OF  
 UNIVERSAL MANUFACTURING CORP.  
 43900 GROESBECK HWY.  
 CLINTON TOWNSHIP, MI 48036  
 PH: (586) 463-2560  
 FAX: (586) 463-2964

JOB NO.:

COMPONENT:

**26-TAPR**

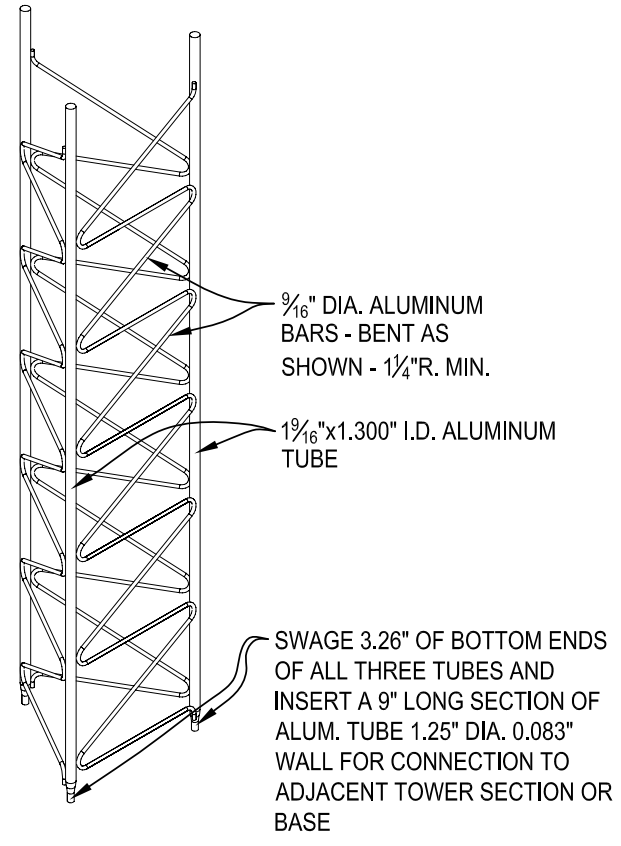
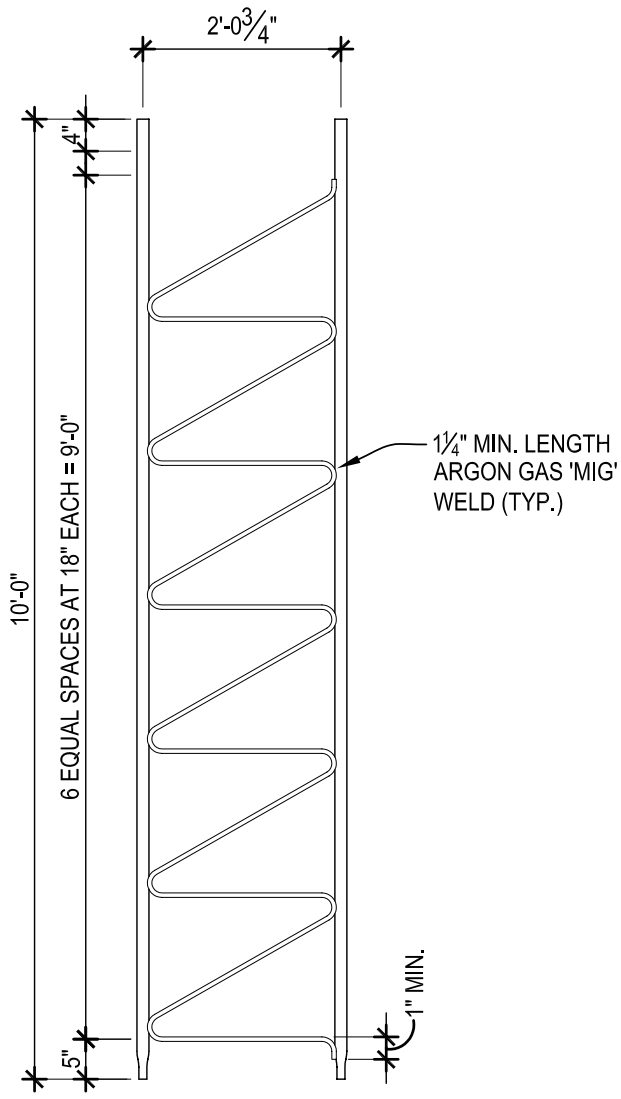

**ISOMETRIC** 3  
SCALE: N.T.S.

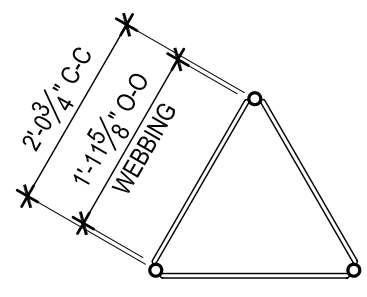

**PLAN VIEW** 1  
SCALE: 1/2"=1'-0"

**ELEVATION** 2  
SCALE: 1/2"=1'-0"

**STRAIGHT SECTION**



**UNIVERSAL TOWERS**  
A DIVISION OF  
UNIVERSAL MANUFACTURING CORP.  
43900 GROESBECK HWY.  
CLINTON TOWNSHIP, MI 48036  
PH: (586) 463-2560  
FAX: (586) 463-2964

JOB NO.:  
COMPONENT:  
**26-STRT**

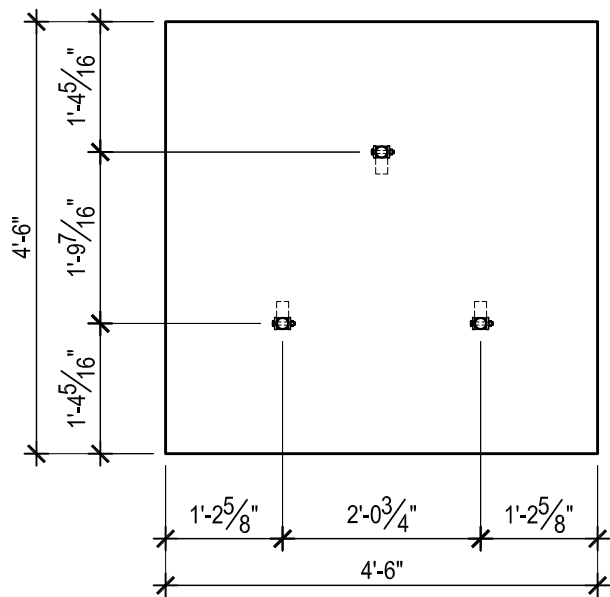

**PLAN VIEW**

SCALE: 1/2"=1'-0"

**1**

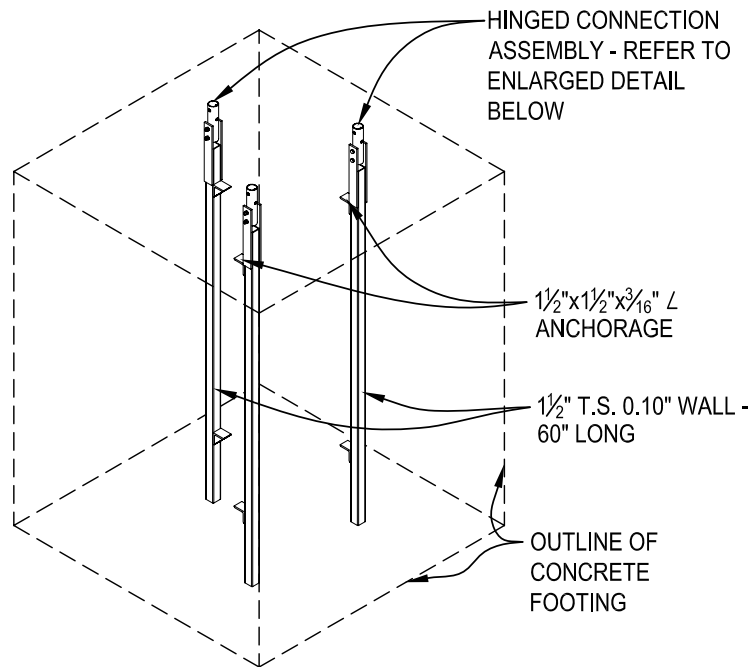

**ISOMETRIC**

SCALE: N.T.S.

**3**

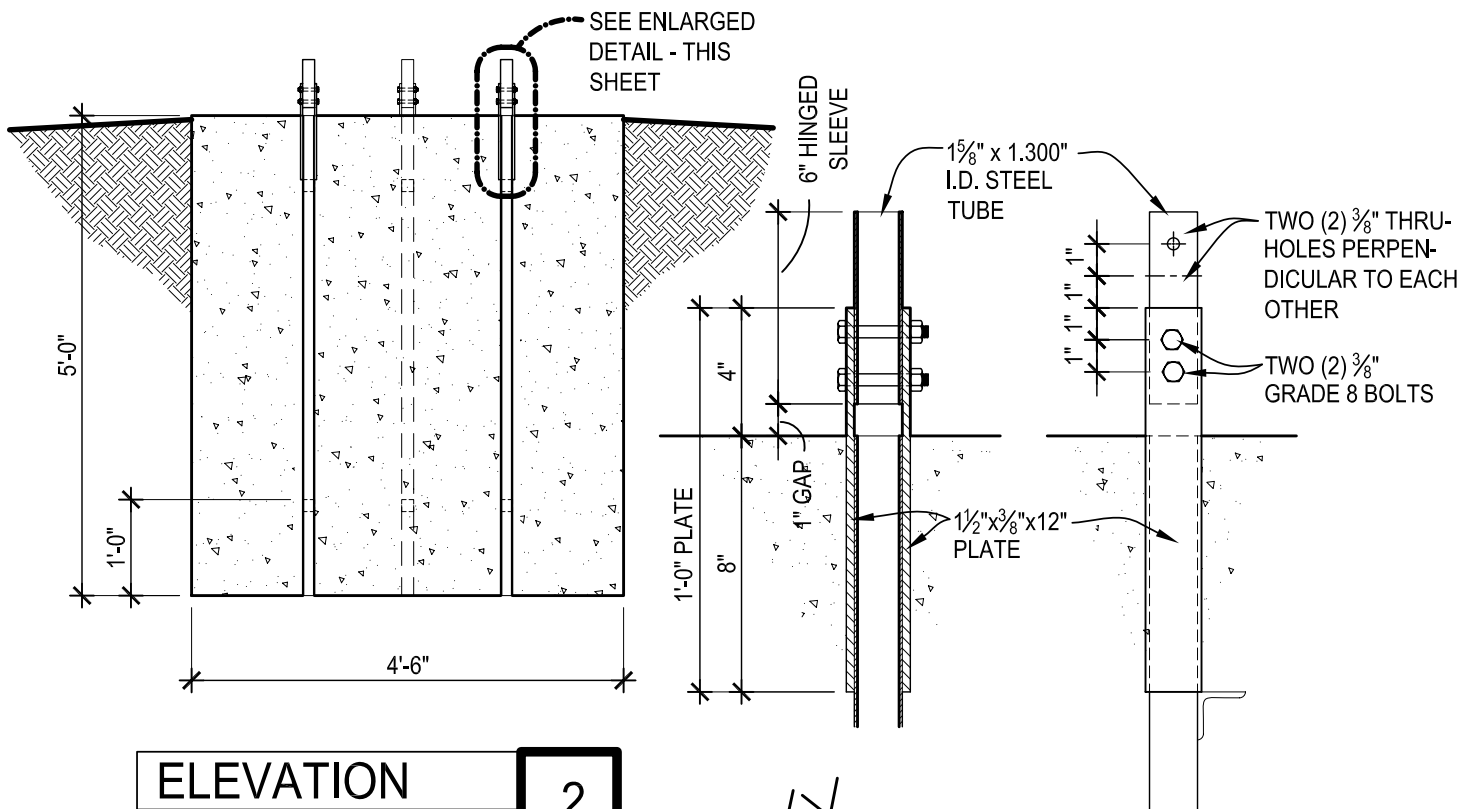

**ELEVATION**

SCALE: 1/2"=1'-0"

**2**

NOTE: FOUNDATIONS ARE DESIGNED FOR FIRM BEARING SOIL.

**BASE FOOTING**



**UNIVERSAL TOWERS**  
 A DIVISION OF  
 UNIVERSAL MANUFACTURING CORP.  
 43900 GROESBECK HWY.  
 CLINTON TOWNSHIP, MI 48036  
 PH: (586) 463-2560  
 FAX: (586) 463-2964

JOB NO.:

COMPONENT:

**B-26**