

# FREESTANDING ALUMINUM TOWER MODEL #3-80

TOTAL WEIGHT: 212 LBS.

WIND LOADING:

80 mph                      3.0 Sq. Ft.  
100 mph                     0.5 Sq. Ft.

Contact Universal Towers to confirm  
geographical location of your tower and  
all wind load implications

11-TOP

14-TAPR

14-STRT

18-TAPR

18-STRT

22-TAPR

22-STRT

26-TAPR

B-26

80'-0"

**WARRANTY**  
UNIVERSAL TOWERS ARE WARRANTED AGAINST DEFECTIVE MATERIAL OR WORKMANSHIP AND ARE SUBJECT TO REPAIR OR TO MATERIAL REPLACEMENT ONLY IF FAILURE RESULTS FROM THESE FACTORS WITHIN ONE YEAR FROM PURCHASE BY USER. THIS WARRANTY DOES NOT EXTEND TO ANY OF OUR PRODUCTS WHICH HAVE BEEN SUBJECTED TO MISUSE, NEGLIGENCE, ACCIDENT, IMPROPER INSTALLATION OR APPLICATION, NOR SHALL IT EXTEND TO UNITS WHICH HAVE BEEN REPAIRED OR SUBSTANTIALLY ALTERED OUTSIDE OF OUR FACTORY. THIS WARRANTY IS IN LIEU OF ALL OTHER WARRANTIES EXPRESSED OR IMPLIED.

**ELEVATION**

SCALE: 3/32"=1'=0"

2

**ISOMETRIC**

SCALE: N.T.S.

1

**ALUMINUM TOWER**



**UNIVERSAL TOWERS**  
A DIVISION OF  
UNIVERSAL MANUFACTURING CORP.  
43900 GROESBECK HWY.  
CLINTON TOWNSHIP, MI 48036  
PH: (586) 463-2560  
FAX: (586) 463-2964

JOB NO.:

COMPONENT:

3-80

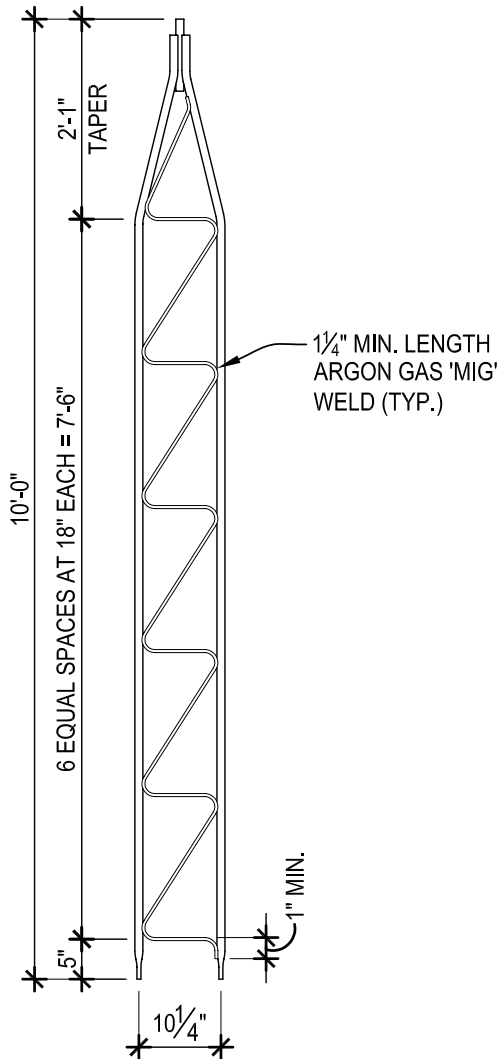

**ELEVATION**

SCALE: 1/2"=1'-0"

**2**

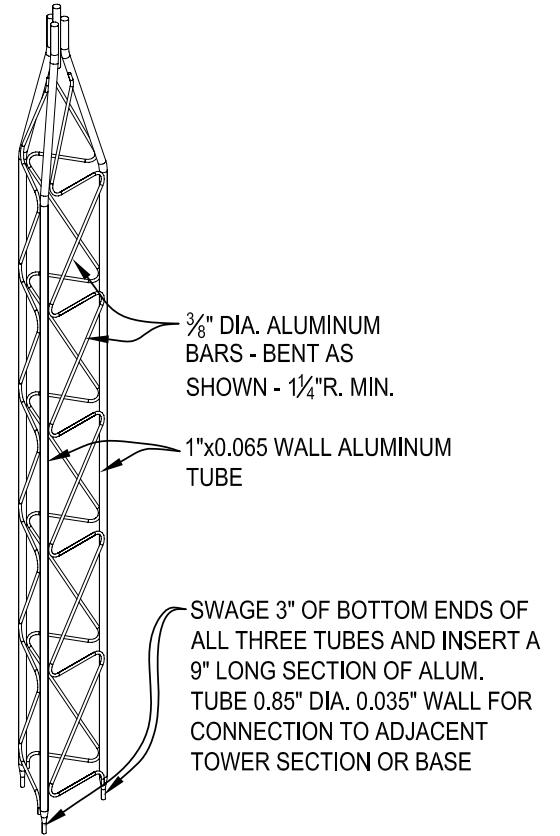

**ISOMETRIC**

SCALE: N.T.S.

**3**

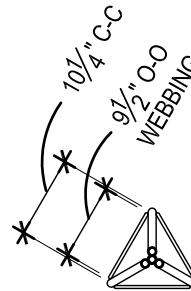

**PLAN VIEW**

SCALE: 1/2"=1'-0"

**1**

**TOP SECTION**



**UNIVERSAL TOWERS**  
 A DIVISION OF  
 UNIVERSAL MANUFACTURING CORP.  
 43900 GROESBECK HWY.  
 CLINTON TOWNSHIP, MI 48036  
 PH: (586) 463-2560  
 FAX: (586) 463-2964

JOB NO.:

COMPONENT:

11-TOP

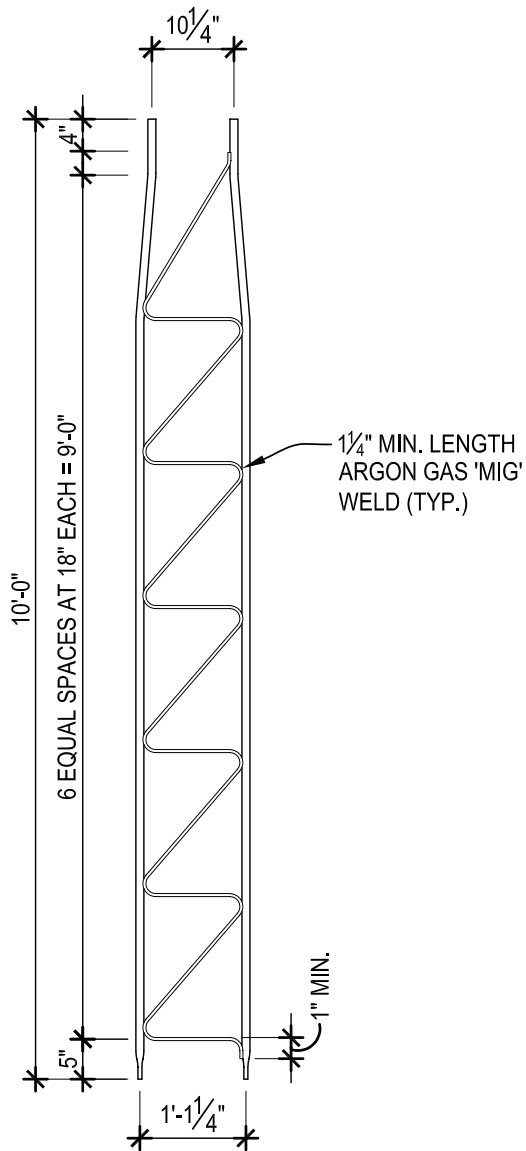

**ELEVATION**

SCALE: 1/2"=1'-0"

**2**

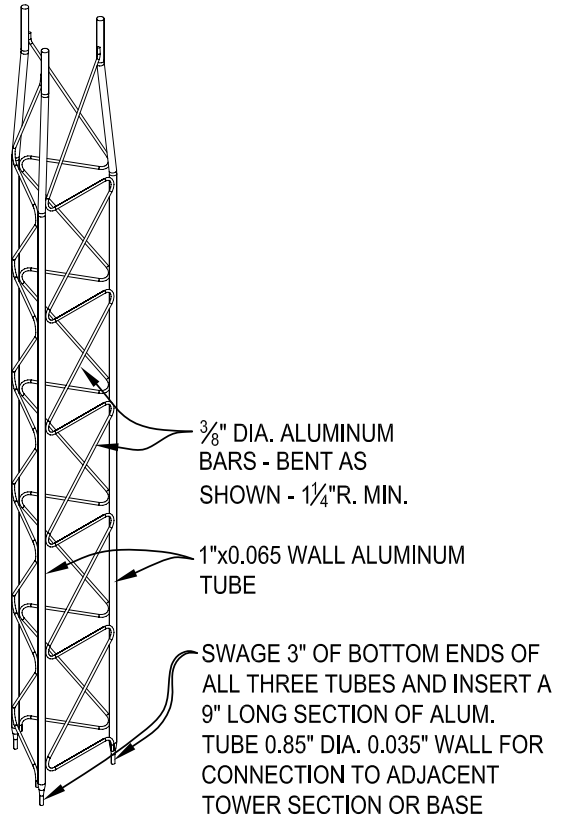

**ISOMETRIC**

SCALE: N.T.S.

**3**

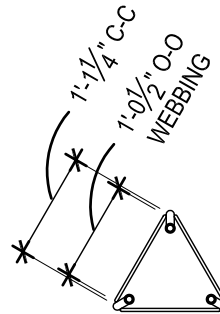

**PLAN VIEW**

SCALE: 1/2"=1'-0"

**1**

**TAPERED SECTION**



**UNIVERSAL TOWERS**  
 A DIVISION OF  
 UNIVERSAL MANUFACTURING CORP.  
 43900 GROESBECK HWY.  
 CLINTON TOWNSHIP, MI 48036  
 PH: (586) 463-2560  
 FAX: (586) 463-2964

JOB NO.:

COMPONENT:

**14-TAPR**

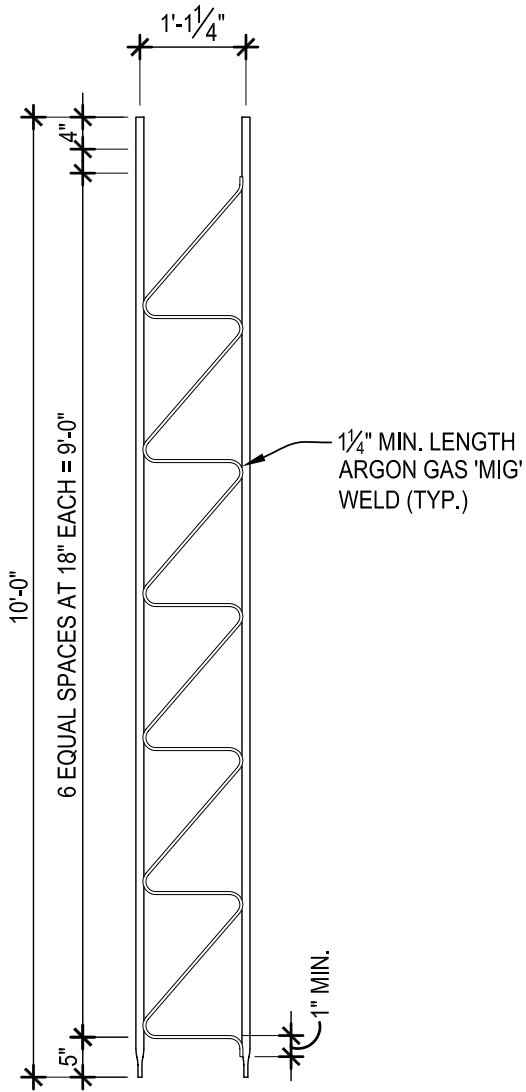

ELEVATION

SCALE: 1/2"=1'-0"

2

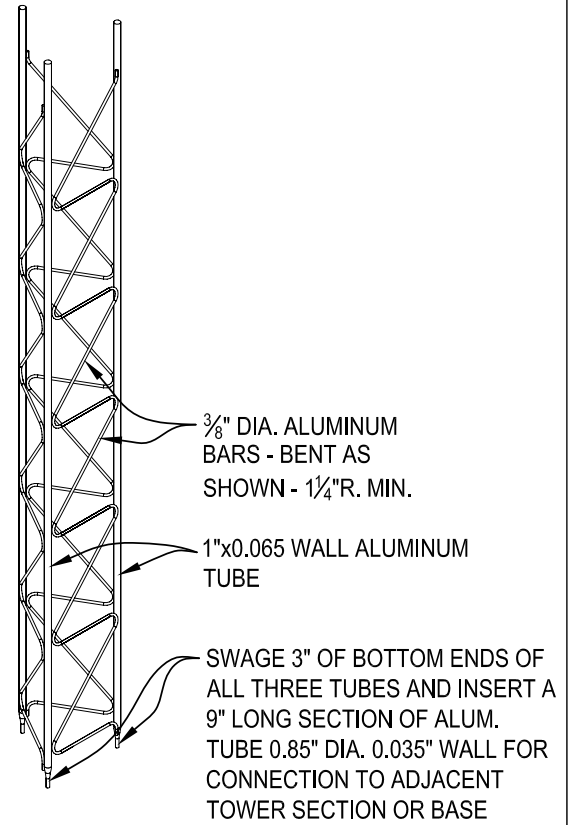

ISOMETRIC

SCALE: N.T.S.

3

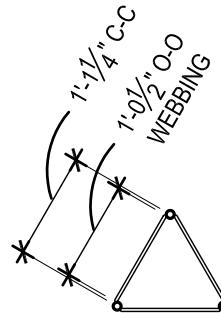

PLAN VIEW

SCALE: 1/2"=1'-0"

1

STRAIGHT SECTION

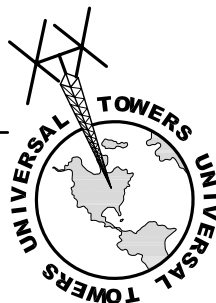

UNIVERSAL TOWERS  
 A DIVISION OF  
 UNIVERSAL MANUFACTURING CORP.  
 43900 GROESBECK HWY.  
 CLINTON TOWNSHIP, MI 48036  
 PH: (586) 463-2560  
 FAX: (586) 463-2964

JOB NO.:

COMPONENT:

14-STRT

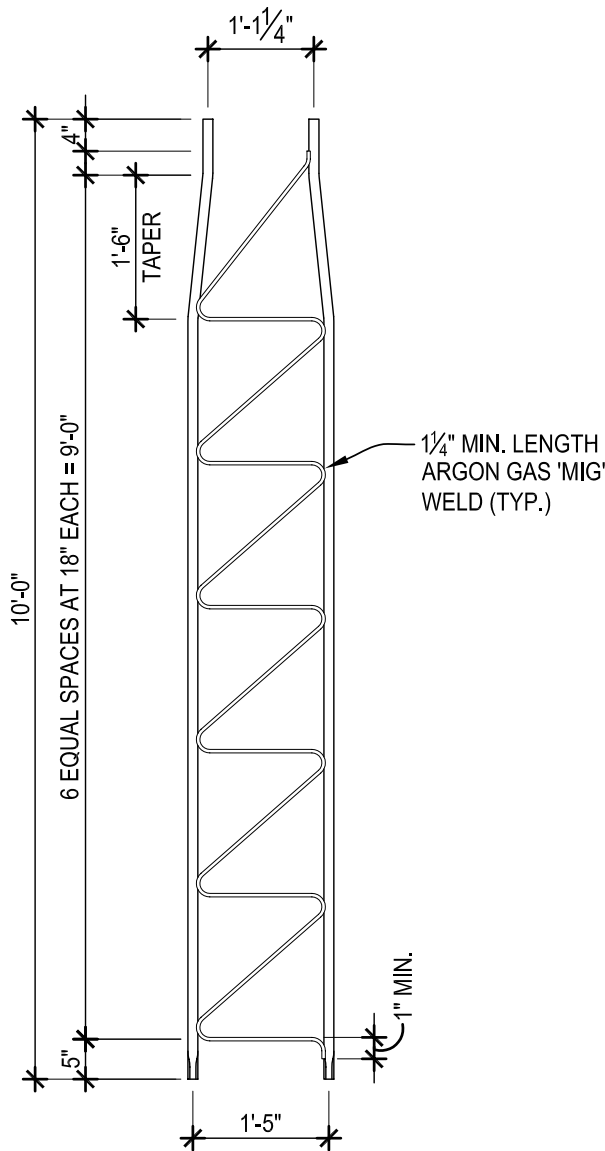

**ELEVATION** 2  
SCALE: 1/2"=1'-0"

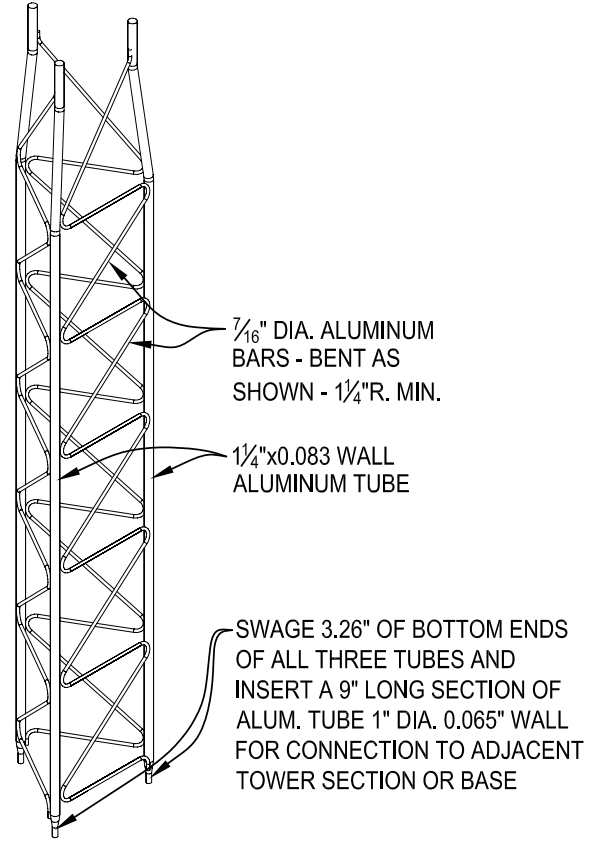

**ISOMETRIC** 3  
SCALE: N.T.S.

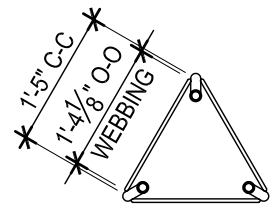

**PLAN VIEW** 1  
SCALE: 1/2"=1'-0"

# TAPERED SECTION



**UNIVERSAL TOWERS**  
A DIVISION OF  
UNIVERSAL MANUFACTURING CORP.  
43900 GROESBECK HWY.  
CLINTON TOWNSHIP, MI 48036  
PH: (586) 463-2560  
FAX: (586) 463-2964

JOB NO.:

COMPONENT:  
**18-TAPR**

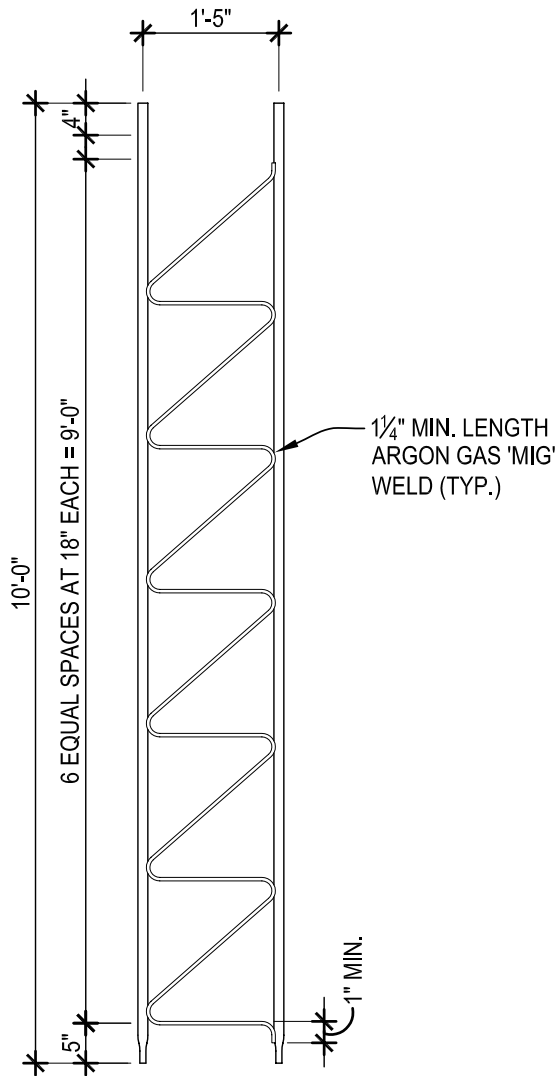

ELEVATION

SCALE: 1/2"=1'-0"

2

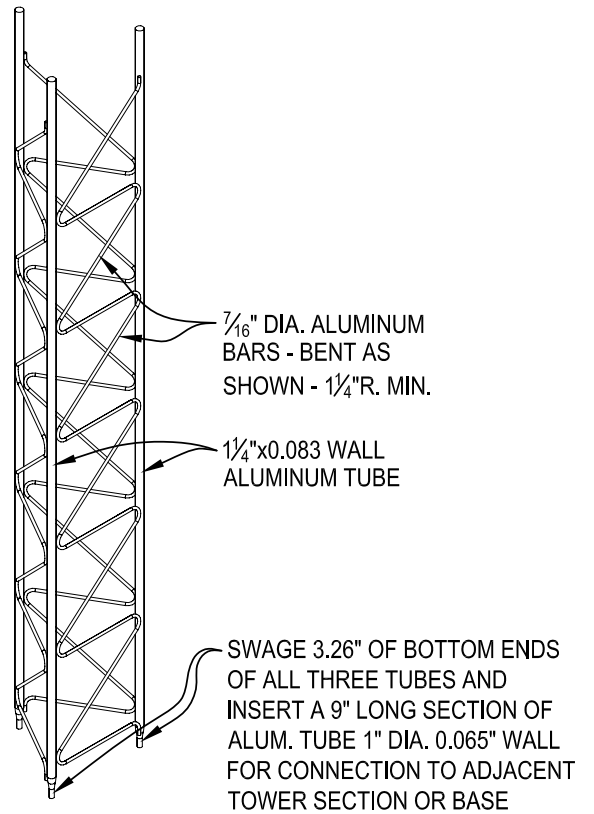

ISOMETRIC

SCALE: N.T.S.

3

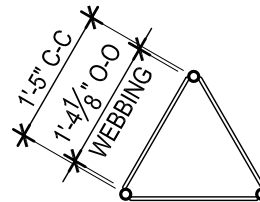

PLAN VIEW

SCALE: 1/2"=1'-0"

1

STRAIGHT SECTION

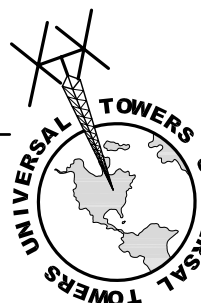

UNIVERSAL TOWERS  
 A DIVISION OF  
 UNIVERSAL MANUFACTURING CORP.  
 43900 GROESBECK HWY.  
 CLINTON TOWNSHIP, MI 48036  
 PH: (586) 463-2560  
 FAX: (586) 463-2964

JOB NO.:

COMPONENT:

18-STRT

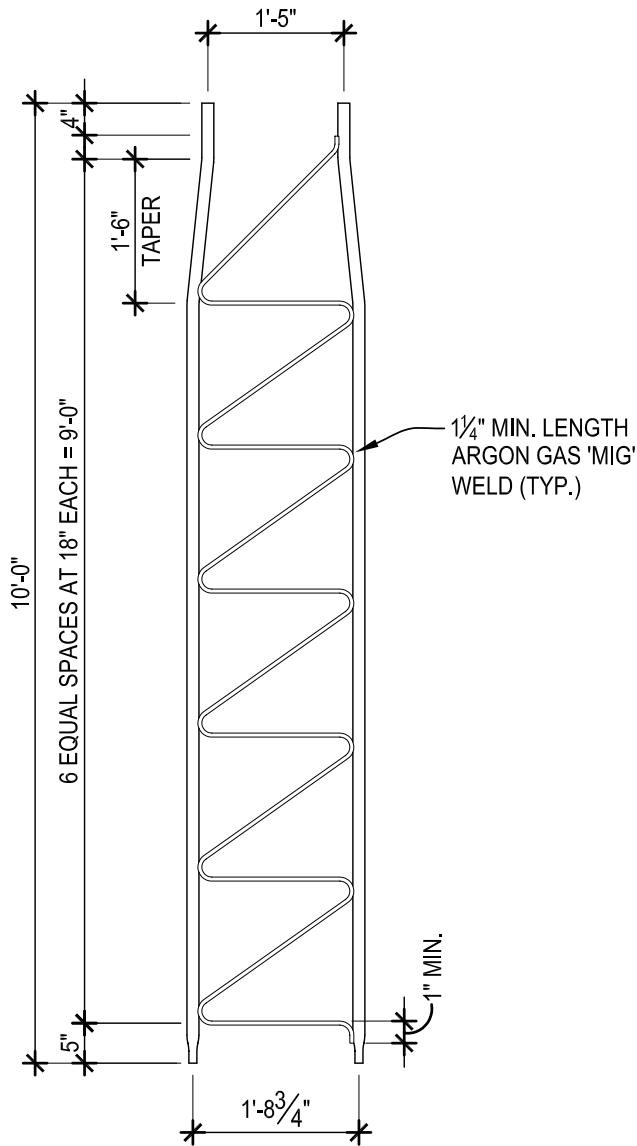

**ELEVATION** 2  
SCALE: 1/2"=1'-0"

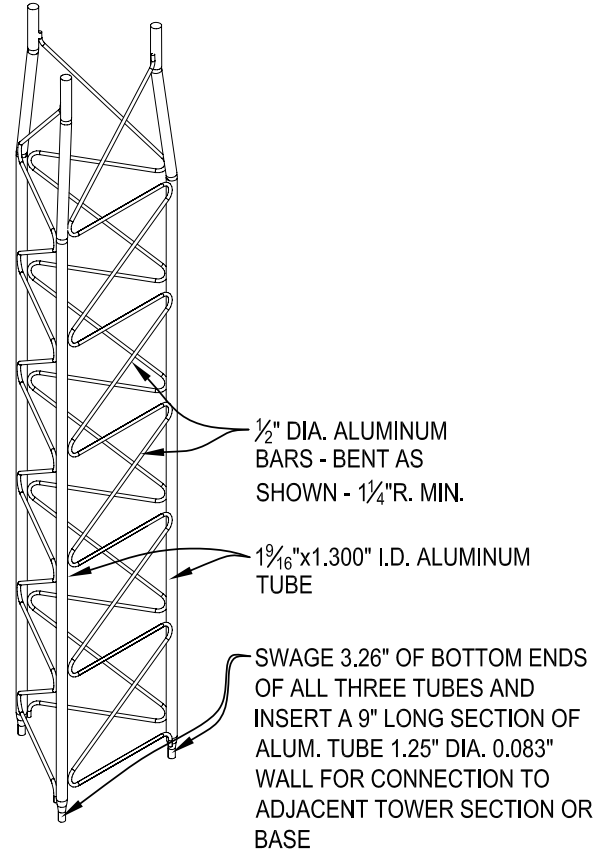

**ISOMETRIC** 3  
SCALE: N.T.S.

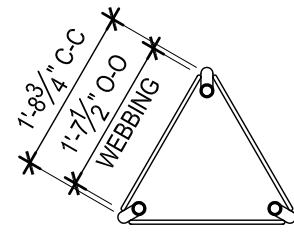

**PLAN VIEW** 1  
SCALE: 1/2"=1'-0"

# TAPERED SECTION

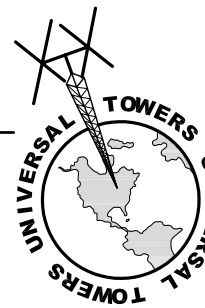

**UNIVERSAL TOWERS**  
A DIVISION OF  
UNIVERSAL MANUFACTURING CORP.  
43900 GROESBECK HWY.  
CLINTON TOWNSHIP, MI 48036  
PH: (586) 463-2560  
FAX: (586) 463-2964

JOB NO.:

COMPONENT:  
**22-TAPR**

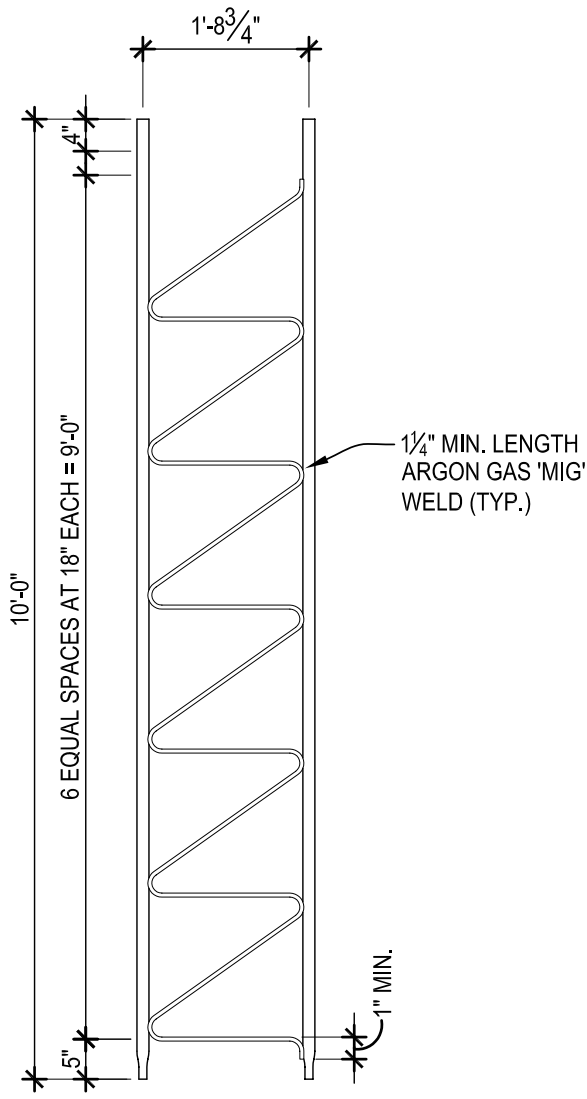

**ELEVATION** 2

SCALE: 1/2"=1'-0"

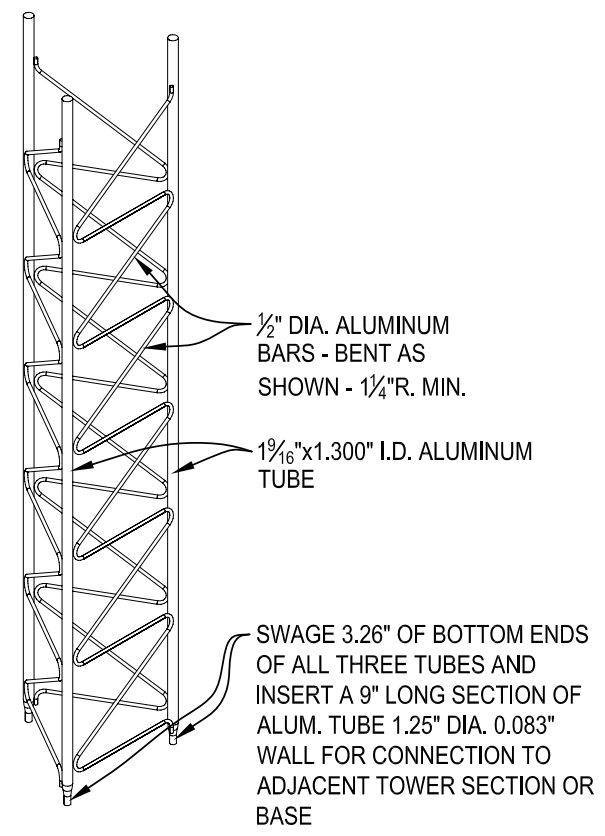

**ISOMETRIC** 3

SCALE: N.T.S.

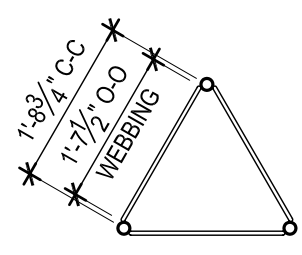

**PLAN VIEW** 1

SCALE: 1/2"=1'-0"

**STRAIGHT SECTION**

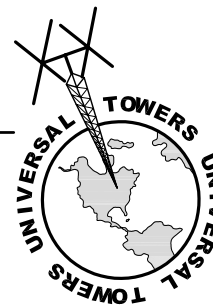

**UNIVERSAL TOWERS**  
 A DIVISION OF  
 UNIVERSAL MANUFACTURING CORP.  
 43900 GROESBECK HWY.  
 CLINTON TOWNSHIP, MI 48036  
 PH: (586) 463-2560  
 FAX: (586) 463-2964

JOB NO.:

COMPONENT:

**22-STRT**



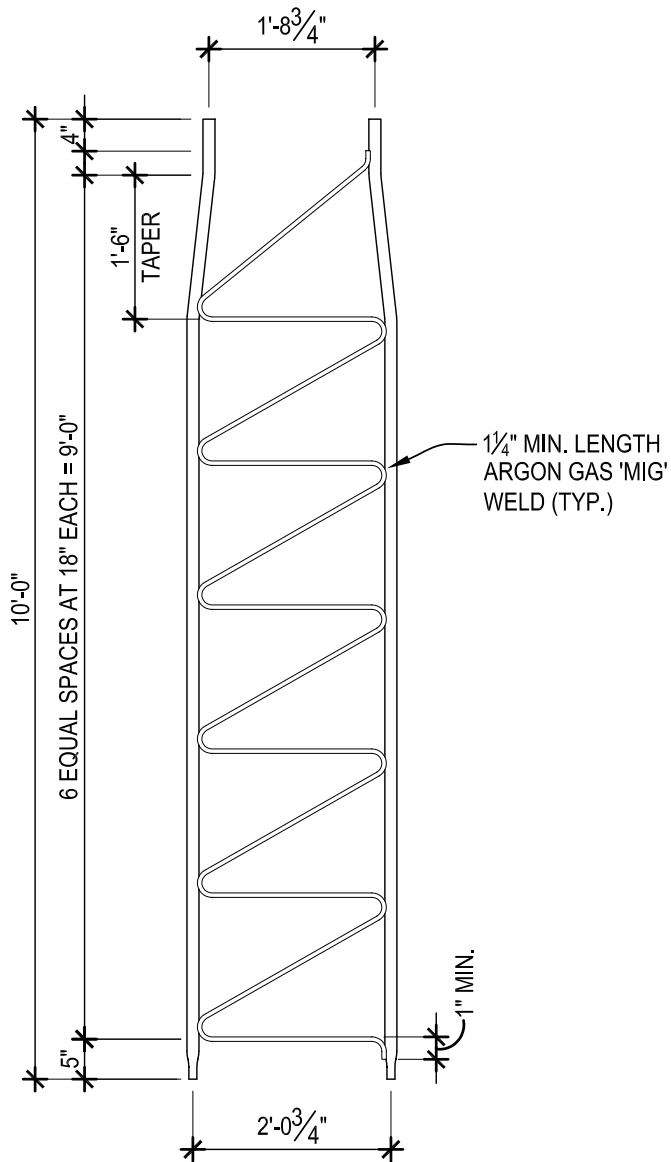

**ELEVATION** 2  
 SCALE: 1/2"=1'-0"

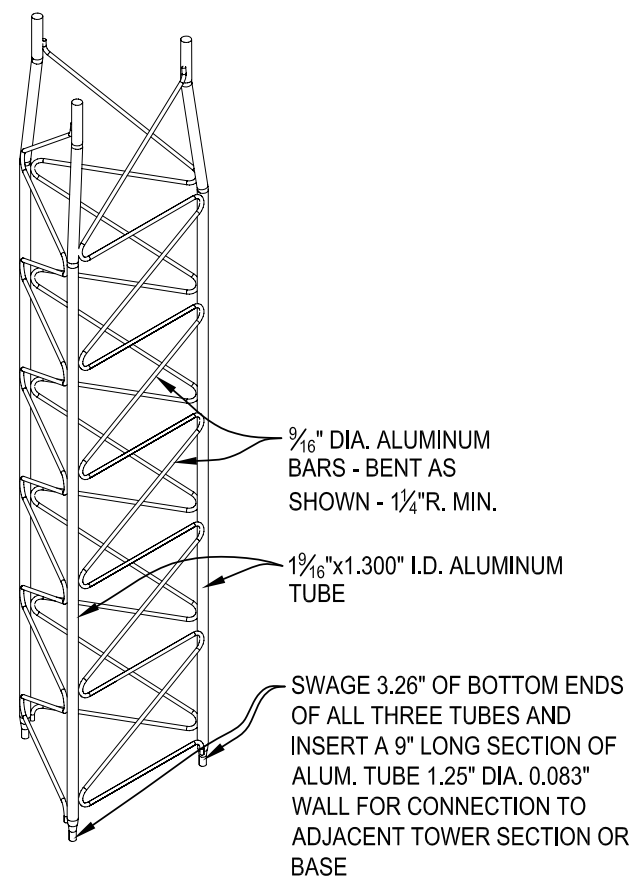

**ISOMETRIC** 3  
 SCALE: N.T.S.

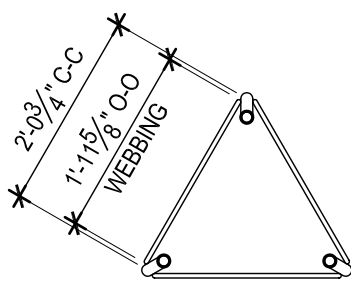

**PLAN VIEW** 1  
 SCALE: 1/2"=1'-0"

# TAPERED SECTION



**UNIVERSAL TOWERS**  
 A DIVISION OF  
 UNIVERSAL MANUFACTURING CORP.  
 43900 GROESBECK HWY.  
 CLINTON TOWNSHIP, MI 48036  
 PH: (586) 463-2560  
 FAX: (586) 463-2964

JOB NO.:

COMPONENT:

26-TAPR

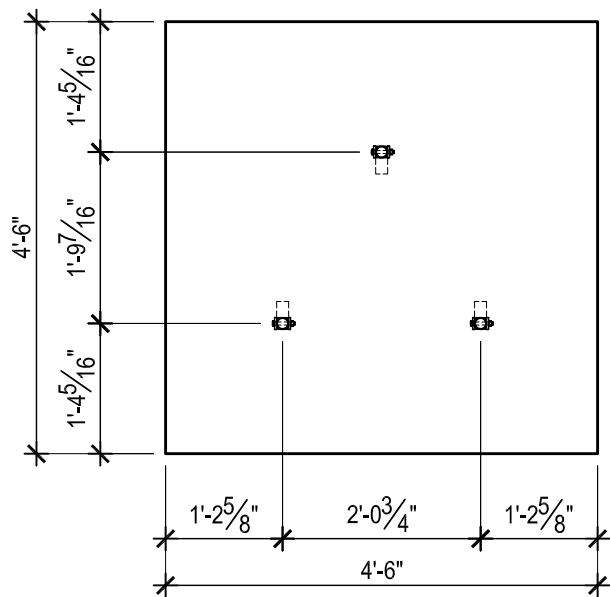

**PLAN VIEW**

SCALE: 1/2"=1'-0"

**1**

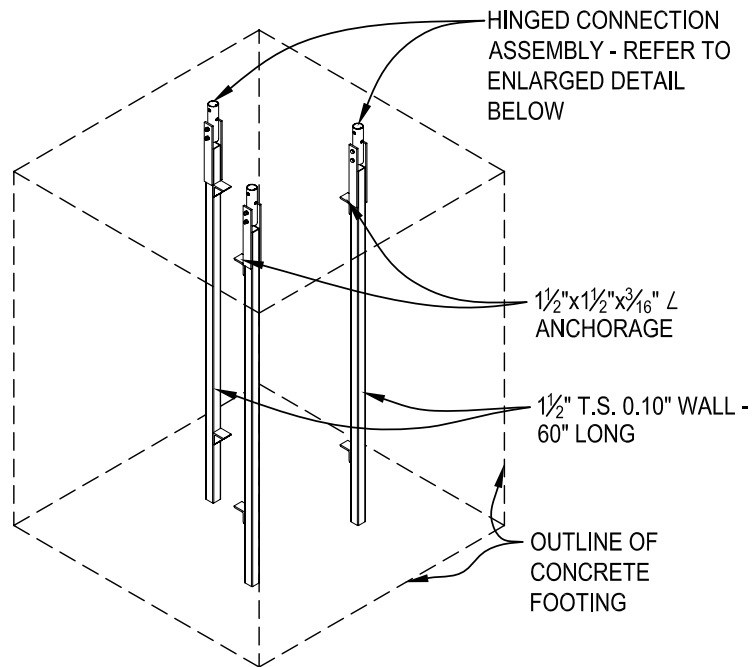

**ISOMETRIC**

SCALE: N.T.S.

**3**

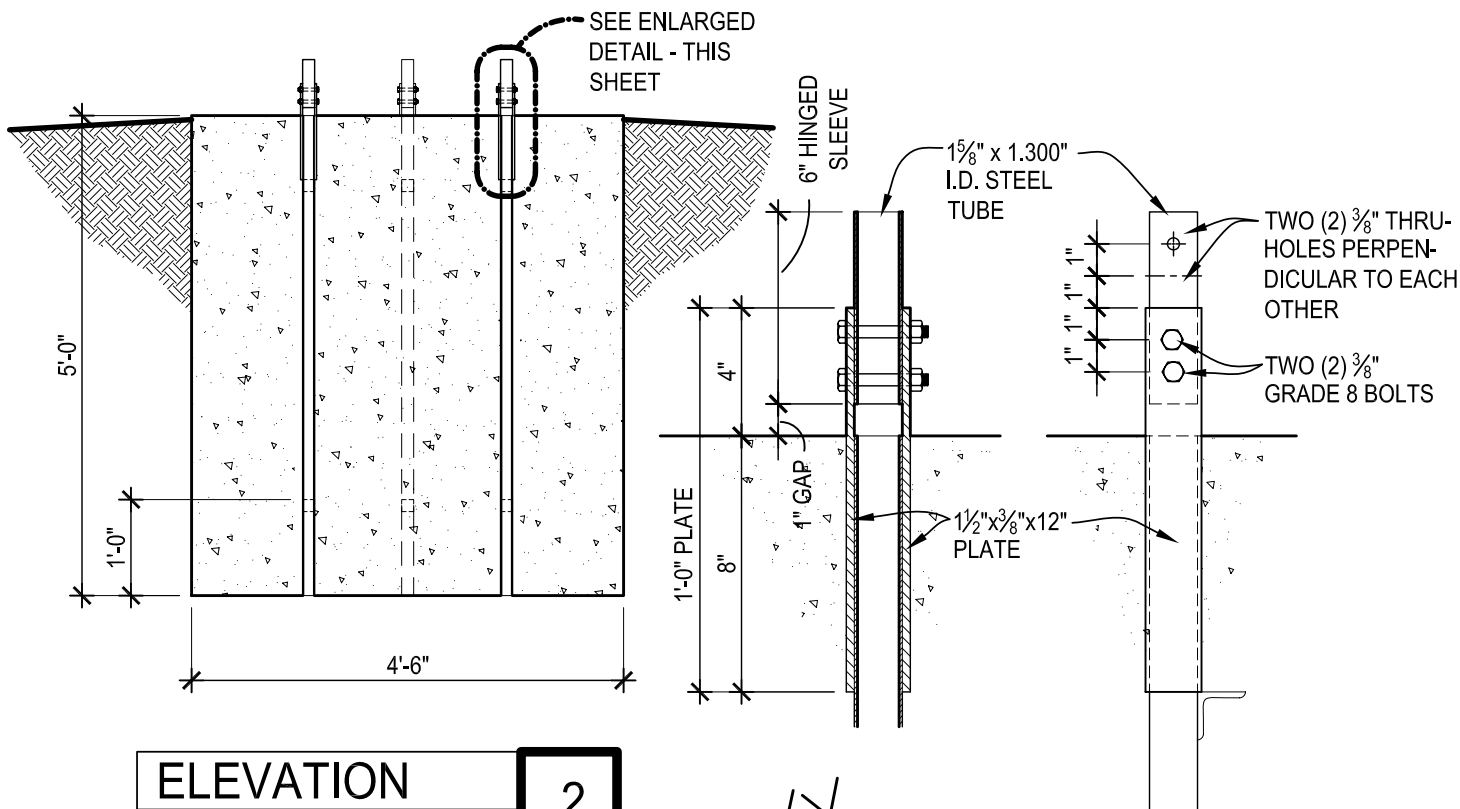

**ELEVATION**

SCALE: 1/2"=1'-0"

**2**

NOTE: FOUNDATIONS ARE DESIGNED FOR FIRM BEARING SOIL.

**BASE FOOTING**



**UNIVERSAL TOWERS**  
 A DIVISION OF  
 UNIVERSAL MANUFACTURING CORP.  
 43900 GROESBECK HWY.  
 CLINTON TOWNSHIP, MI 48036  
 PH: (586) 463-2560  
 FAX: (586) 463-2964

JOB NO.:

COMPONENT:

**B-26**